



U.S. Department of Transportation  
Federal Highway Administration

**ZERO** IS OUR GOAL  
A SAFE SYSTEM IS HOW WE GET THERE

MOTORCYCLE SAFETY NOTEWORTHY PRACTICES:

# Infrastructure and Engineering

FHWA-SA-22-032



**Notice**

This document is disseminated under the sponsorship of the U.S. Department of Transportation in the interest of information exchange. The U.S. Government assumes no liability for the use of the information contained in this document.

The U.S. Government does not endorse products or manufacturers. Trademarks or manufacturers' names appear in this report only because they are considered essential to the objective of the document.

**Quality Assurance Statement**

The Federal Highway Administration (FHWA) provides high-quality information to serve Government, industry, and the public in a manner that promotes public understanding. Standards and policies are used to ensure and maximize the quality, objectivity, utility, and integrity of its information. FHWA periodically reviews quality issues and adjusts its programs and processes to ensure continuous quality improvement.

## TECHNICAL REPORT DOCUMENTATION PAGE

<b>1. Report No.</b> FHWA-SA-22-031	<b>2. Government Accession No.</b>	<b>3. Recipient's Catalog No.</b>	
<b>4. Title and Subtitle</b> <i>Motorcycle Safety Noteworthy Practices: Infrastructure and Engineering</i>		<b>5. Report Date</b> June 2022	
		<b>6. Performing Organization Code</b>	
<b>7. Authors</b> Georgene Geary and Michael Manser		<b>8. Performing Organization Report No.</b>	
<b>9. Performing Organization Name and Address</b> Texas A&M Transportation Institute The Texas A&M University System College Station, Texas 77843-3135		<b>10. Work Unit No. (TRAIS)</b>	
		<b>11. Contract or Grant No.</b> 693JJ320D000023	
<b>12. Sponsoring Agency Name and Address</b> U.S. Department of Transportation Federal Highway Administration 1200 New Jersey Avenue, SE Washington, DC 20590		<b>13. Type of Report and Period Covered</b> Final Report	
		<b>14. Sponsoring Agency Code</b>	
<b>15. Supplementary Notes</b> Task Order Manager for this report is Guan Xu.  Project Title: Addressing the Motorcyclist Advisory Council Recommendations			
<b>16. Abstract</b> Motorcyclists are at significantly greater risk of fatalities and injuries when involved in a crash compared to passenger vehicle drivers. A general source of this risk is associated with the roadway infrastructure and can include items like reduced friction surfaces, poor roadway maintenance, and barriers. While research has examined a variety of roadway infrastructure countermeasures to improve motorcyclist safety in terms of reducing the propensity for a crash and reducing the severity of a crash after one occurs, there is a need to transfer this information to practitioners so that the countermeasures can be implemented. This report contains summary information on nine infrastructure-based countermeasures intended to improve motorcyclist safety. The countermeasures are presented as noteworthy practices that are in use currently by one or more State departments of transportation.			
<b>17. Key Words</b> Motorcycle safety, noteworthy practices, advisory sign, steel plates, high-friction surface treatment, road safety audit, work zone, friction and pavement markings, protection system, barriers		<b>18. Distribution Statement</b> No restrictions. This document is available to the public through the National Technical Information Service Alexandria, Virginia 22312	
<b>19. Security Classif. (of this report)</b> Unclassified	<b>20. Security Classif. (of this page)</b> Unclassified	<b>21. No of Pages</b> 32	<b>22. Price</b>

## SI\* (Modern Metric) Conversion Factors

APPROXIMATE CONVERSIONS TO SI UNITS				
Symbol	When You Know	Multiply By	To Find	Symbol
<b>Length</b>				
<b>in</b>	inches	25.4	millimeters	mm
<b>ft</b>	feet	0.305	meters	m
<b>yd</b>	yards	0.914	meters	m
<b>mi</b>	miles	1.61	kilometers	km
<b>Area</b>				
<b>in<sup>2</sup></b>	square inches	645.2	square millimeters	mm <sup>2</sup>
<b>ft<sup>2</sup></b>	square feet	0.093	square meters	m <sup>2</sup>
<b>yd<sup>2</sup></b>	square yard	0.836	square meters	m <sup>2</sup>
<b>ac</b>	acres	0.405	hectares	ha
<b>mi<sup>2</sup></b>	square miles	2.59	square kilometers	km <sup>2</sup>
<b>Volume</b>				
<b>fl oz</b>	fluid ounces	29.57	milliliters	mL
<b>gal</b>	gallons	3.785	liters	L
<b>ft<sup>3</sup></b>	cubic feet	0.028	cubic meters	m <sup>3</sup>
<b>yd<sup>3</sup></b>	cubic yards	0.765	cubic meters	m <sup>3</sup>
<b>NOTE: volumes greater than 1000 L shall be shown in m<sup>3</sup></b>				
<b>Mass</b>				
<b>oz</b>	ounces	28.35	grams	g
<b>lb</b>	pounds	0.454	kilograms	kg
<b>T</b>	short tons (2000 lb)	0.907	megagrams (or "metric ton")	Mg (or "t")
<b>Temperature (exact degrees)</b>				
<b>°F</b>	Fahrenheit	$\frac{5}{9}(F-32)$ or $(F-32)/1.8$	Celsius	°C
<b>Illumination</b>				
<b>fc</b>	foot-candles	10.76	lux	lx
<b>fl</b>	foot-Lamberts	3.426	candela/m <sup>2</sup>	cd/m <sup>2</sup>
<b>Force and Pressure or Stress</b>				
<b>lbf</b>	poundforce	4.45	newtons	N
<b>lbf/in<sup>2</sup></b>	poundforce per square inch	6.89	kilopascals	kPa
APPROXIMATE CONVERSIONS FROM SI UNITS				
Symbol	When You Know	Multiply By	To Find	Symbol
<b>Length</b>				
<b>mm</b>	millimeters	0.039	inches	in
<b>m</b>	meters	3.28	feet	ft
<b>m</b>	meters	1.09	yards	yd
<b>km</b>	kilometers	0.621	miles	mi
<b>Area</b>				
<b>mm<sup>2</sup></b>	square millimeters	0.0016	square inches	in <sup>2</sup>
<b>m<sup>2</sup></b>	square meters	10.764	square feet	ft <sup>2</sup>
<b>m<sup>2</sup></b>	square meters	1.195	square yards	yd <sup>2</sup>
<b>ha</b>	hectares	2.47	acres	ac
<b>km<sup>2</sup></b>	square kilometers	0.386	square miles	mi <sup>2</sup>
<b>Volume</b>				
<b>mL</b>	milliliters	0.034	fluid ounces	fl oz
<b>L</b>	liters	0.264	gallons	gal
<b>m<sup>3</sup></b>	cubic meters	35.314	cubic feet	ft <sup>3</sup>
<b>m<sup>3</sup></b>	cubic meters	1.307	cubic yards	yd <sup>3</sup>
<b>Mass</b>				
<b>g</b>	grams	0.035	ounces	oz
<b>kg</b>	kilograms	2.202	pounds	lb
<b>Mg (or "t")</b>	megagrams (or "metric ton")	1.103	short tons (2000 lb)	T
<b>Temperature (exact degrees)</b>				
<b>°C</b>	Celsius	$1.8C+32$	Fahrenheit	°F
<b>Illumination</b>				
<b>lx</b>	lux	0.0929	foot-candles	fc
<b>cd/m<sup>2</sup></b>	candela/m <sup>2</sup>	0.2919	foot-Lamberts	fl
<b>Force and Pressure or Stress</b>				
<b>N</b>	newtons	0.225	poundforce	lbf
<b>kPa</b>	kilopascals	0.145	poundforce per square inch	lbf/in <sup>2</sup>

\*SI is the symbol for the International System of Units. Appropriate rounding should be made to comply with Section 4 of ASTM E380. (Revised March 2003)

## INTRODUCTION

On December 25, 2015, President Obama signed the Fixing America's Surface Transportation (FAST) Act. This legislation reestablished the Motorcyclist Advisory Council (MAC) and authorized MAC to address "infrastructure issues of concern to motorcyclists." The MAC recommendations specifically addressed "road design, construction, and maintenance practices" and their influence on motorcycle safety.\* MAC identified the following 11 areas related to infrastructure maintenance and construction that affect motorcyclists' safety:

- Pothole maintenance.
- Open milled road surfaces.
- Raised manhole covers.
- Steel plates.
- Uneven pavement conditions.
- Gravel or debris on roadway.
- Traffic barrel sight criteria.
- Chip seals.
- Excessive over-band crack fillers and joint sealant.
- Low-friction pavement markings.
- Traffic-actuated signal detection systems that do not detect a motorcycle.

\* The full MAC report and other safety resources can be found at <https://safety.fhwa.dot.gov/motorcycles/>.



## CONTENTS

This document is a compilation of noteworthy practices (NPs) that address one or more of the MAC-identified areas of infrastructure concern. The NPs included herein are:

Work Zone Safety Training Specifically Related to Motorcycles .....	8
Temporary Steel Plates.....	10
Friction and Pavement Markings, Southern States* .....	12
Friction and Pavement Markings, Northern States* .....	14
Motorcycle Advisory Sign Guidance .....	16
Detecting Motorcycles at Traffic Signals .....	18
High-Friction Surface Treatment for Motorcycle Safety in Curves .....	20
Motorcycle Road Safety Audit.....	22
Motorcycle Protection System .....	24

## NOTEWORTHY PRACTICE—

# WORK ZONE SAFETY TRAINING SPECIFICALLY RELATED TO MOTORCYCLES

Source: National Workzone Safety Information Clearinghouse website, <https://www.workzonesafety.org>

## NATIONAL WORK ZONE SAFETY INFORMATION CLEARINGHOUSE (WORKZONESAFETY.ORG)

**Subject Areas\*:** Pothole Maintenance, Open Milled Road Surfaces, Raised Manhole Covers, Steel Plates, Uneven Pavement Conditions, Gravel or Debris on Roadway, Traffic Barrel Sight Criteria, Chip Seals, Excessive Over-Band Crack Fillers, Low-Friction Pavement Markings, Traffic-Actuated Signal Detection Systems

### Strategy

- Access clearinghouse and training resource to address motorcycle safety

## BACKGROUND

Motorcycles comprise only 3 percent of the registered vehicles and only 0.6 percent of vehicle miles traveled but account for 14 percent of motor vehicle traffic fatalities.<sup>(1)</sup> This means that motorcycles are overrepresented in fatal accidents in the United States. Awareness of the special needs of motorcyclists could go a long way in combating these grim statistics.

## CHALLENGES

A recent research synthesis on motorcycle safety<sup>(1)</sup> found that very few State construction specifications even consider the special needs of motorcycles. The report also noted a lack of training for engineers, contractors, and agency personnel concerning the specific aspects of motorcycle safety. On a positive note, one training source that was identified does have the opportunity to have a huge impact on motorcycle safety. The National Work Zone Safety Information Clearinghouse ([workzonesafety.org](https://www.workzonesafety.org)) is a highly successful public-private partnership focused

\* The Motorcyclist Advisory Council (MAC) identified 11 areas related to infrastructure that affect motorcyclists' safety. The full MAC report and other resources can be found at <https://safety.fhwa.dot.gov/motorcycles/>.



on work zone safety. The site, funded by a Federal Highway Administration (FHWA) grant, was initiated in 1997. The website and the American Road and Transportation Builders Association (ARTBA) Work Zone Safety Online Management System are managed by the ARTBA Transportation Development Foundation (TDF). The website resources have been used by all 50 States, Puerto Rico, and other countries.

### NOTEWORTHY PRACTICE DESCRIPTION

Recent efforts sponsored by FHWA and the Texas Department of Transportation (TxDOT) have provided new training materials specifically focused on motorcycle safety. TxDOT, through the Texas Transportation Institute, developed a 30-minute online training module named “Reducing Risks to Motorcycles in Texas Work Zones.” While this training is specific to Texas, ARTBA TDF has also developed a one-hour online training program, “Work Zone Safety for Motorcycles and Bicycles,” which covers work zones in general and even includes a quiz and certificate of completion.<sup>(2)</sup> The website also provides a guide that specifically addresses motorcyclist and bicyclist safety needs around work zones titled Guidelines on Motorcycle and Bicycle Work Zone Safety.<sup>(3)</sup> The guide (see Figure 1) includes eight recommended practices and actions agencies can take to address motorcycle safety in the areas of:

- Addressing pavement unevenness.
- Using appropriate design speeds in work zones.
- Using advanced warning signs specifically for motorcycles.
- Using portable (changeable) message signs as needed for added visibility.
- Addressing steel plates.
- Being cognizant of pavement markings’ effect on motorcycles.
- Including motorcycles in agency guidelines and design policy.
- Regularly monitoring pavement conditions.

### TAKEAWAYS/LESSONS LEARNED

The next step is to share the training and make others aware of the benefits of this training. This course offers training on how to design and operate work zones with motorcyclists’ safety in mind: [https://artba.ispringmarket.com/content/81/info/Work\\_Zone\\_Safety\\_for\\_Motorcycles\\_and\\_Bicycles\\_-\\_BETA\\_Version](https://artba.ispringmarket.com/content/81/info/Work_Zone_Safety_for_Motorcycles_and_Bicycles_-_BETA_Version)

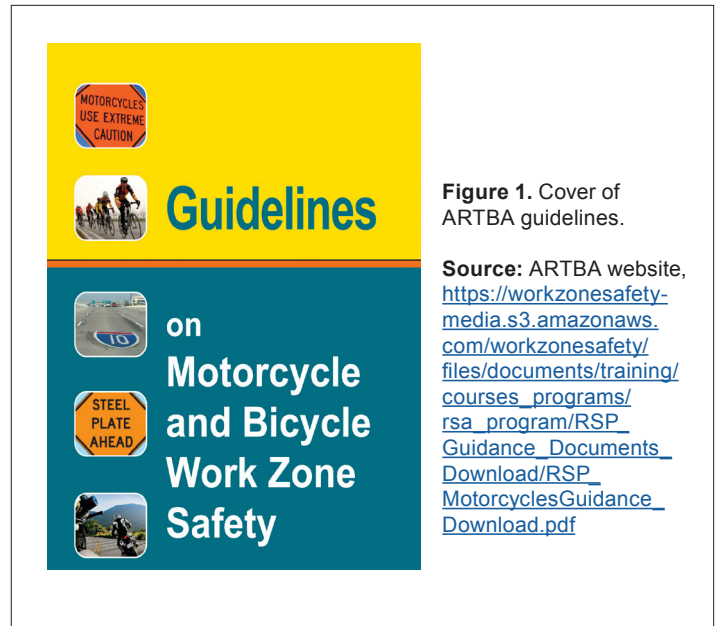

### REFERENCES

1. Geary, G., Dixon, K., Aspelin, K., & Manser, M. (2021). *Addressing the Motorcyclist Advisory Council recommendations: Synthesis on roadway geometry, pavement design, and pavement construction and maintenance practices* (Report No. FHWA-SA-21-090). Federal Highway Administration. [https://safety.fhwa.dot.gov/motorcycles/docs/FHWA-SA-21-090\\_Addressing\\_MAC\\_Recommendations\\_Rpt.pdf](https://safety.fhwa.dot.gov/motorcycles/docs/FHWA-SA-21-090_Addressing_MAC_Recommendations_Rpt.pdf)
2. American Road and Transportation Builders Association. (n.d.). Workzone safety for motorcycles and bicycles. [https://artba.ispringmarket.com/content/81/info/Work\\_Zone\\_Safety\\_for\\_Motorcycles\\_and\\_Bicycles\\_-\\_BETA\\_Version](https://artba.ispringmarket.com/content/81/info/Work_Zone_Safety_for_Motorcycles_and_Bicycles_-_BETA_Version)
3. American Road and Transportation Builders Association. (2011). *Guidelines on Motorcycle and Bicycle Workzone Safety*. [https://www.workzonesafety.org/files/documents/training/courses\\_programs/rsa\\_program/RSP\\_Guidance\\_Documents\\_Download/RSP\\_MotorcyclesGuidance\\_Download-508.pdf](https://www.workzonesafety.org/files/documents/training/courses_programs/rsa_program/RSP_Guidance_Documents_Download/RSP_MotorcyclesGuidance_Download-508.pdf)

## NOTEWORTHY PRACTICE— TEMPORARY STEEL PLATES



Source: Shutterstock

### CITY OF ATLANTA DOT

**Subject Area\*:** Steel Plates

#### Strategies

- Develop detailed standard for temporary steel plates
- Identify advanced signage
- Identify tape markings for visibility
- Identify standard taper details

### BACKGROUND

Roadways not only move vehicular traffic, sometimes they also include underground utilities that travel across or even along a roadway. Maintenance crews typically access these underground utilities by trenching the roadway. Steel plates are often used to cover the open trenches to allow traffic to continue to use the roadway while work is being performed on the underground facilities. While all vehicles can experience adverse impacts from improperly installed steel plates, motorcyclists find the plates

especially challenging. The Motorcyclist Advisory Council (MAC) identified steel plates as one of the 11 specific construction and maintenance practices of concern. MAC noted that steel plates often are raised, creating a jarring bump and providing limited friction.

### CHALLENGES

Steel plates are typically greater than an inch in thickness, which can jar a motorcyclist if not recessed or tapered in correctly. The surface of the steel plate, if untreated, can become slick during a rain event or when covered with leaves. It has been documented that some State Departments of Transportation (DOTs), like Delaware DOT, have standard details for tapering in the steel plates. In addition, Washington State DOT requires advanced warning signs for steel plates. Virginia DOT performed research on steel plates and recommended reflective tape be used on the corners of the plates to assist motorcyclists in being more aware of the plates.<sup>(1)</sup> All of these methods are beneficial to motorcyclists because they provide awareness, reduce the pavement unevenness, and improve frictional properties—all factors that influence motorcyclists' safety.

\* The Motorcyclist Advisory Council (MAC) identified 11 areas related to infrastructure that affect motorcyclists' safety. The full MAC report and other resources can be found at <https://safety.fhwa.dot.gov/motorcycles/>.

## NOTEWORTHY PRACTICE DESCRIPTION

The City of Atlanta Public Right-of-Way Manual<sup>(2)</sup> includes specific requirements for steel plates used for temporary purposes that includes all the recommended practices in one manual. The document specifically notes the following:

- “Metal plates shall be coated with a skid-resistant finish.”
- “Metal plates will have white reflective marking tape on all four corners of each end plate” (see Figure 2).

The manual also includes details for recessing steel plates on high-speed roadways to provide for a smoother surface (Figure 3).

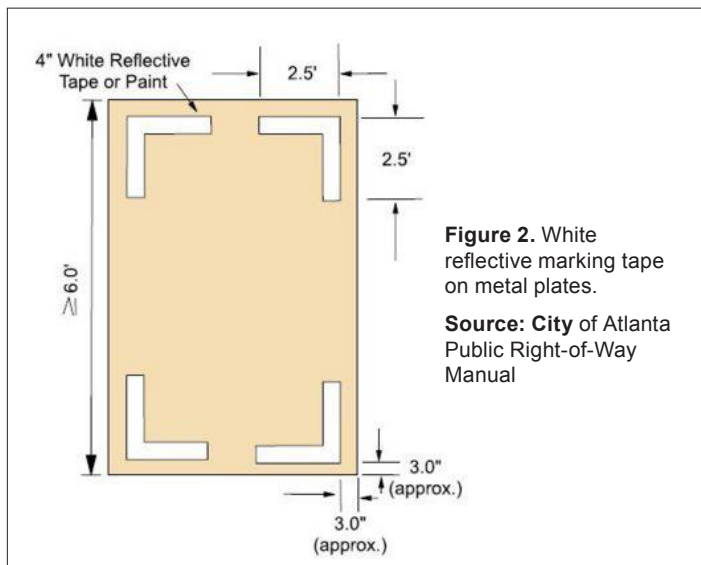

## TAKEAWAYS/LESSONS LEARNED

Roadway cuts are especially common in utility-heavy metropolitan areas. Metal plates are often used as temporary measures to keep the roadway open to traffic as the underground work is progressing. Clear and concise guidance on how to reduce the risk from metal plates to motorcyclists and other road users (bicyclists would also benefit, especially in metropolitan areas) should be shared and emulated.

## REFERENCES

1. Geary, G., Dixon, K., Aspelin, K., & Manser, M. (2021). *Addressing the Motorcyclist Advisory Council recommendations: Synthesis on roadway geometry, pavement design, and pavement construction and maintenance practices* (Report No. FHWA-SA-21-090). Federal Highway Administration. [https://safety.fhwa.dot.gov/motorcycles/docs/FHWA-SA-21-090\\_Addressing\\_MAC\\_Recommendations\\_Rpt.pdf](https://safety.fhwa.dot.gov/motorcycles/docs/FHWA-SA-21-090_Addressing_MAC_Recommendations_Rpt.pdf)
2. City of Atlanta Department of Public Works, Office of Transportation. (2019). *City of Atlanta public right-of-way manual*. <https://www.atlantaga.gov/home/showpublisheddocument?id=44400>

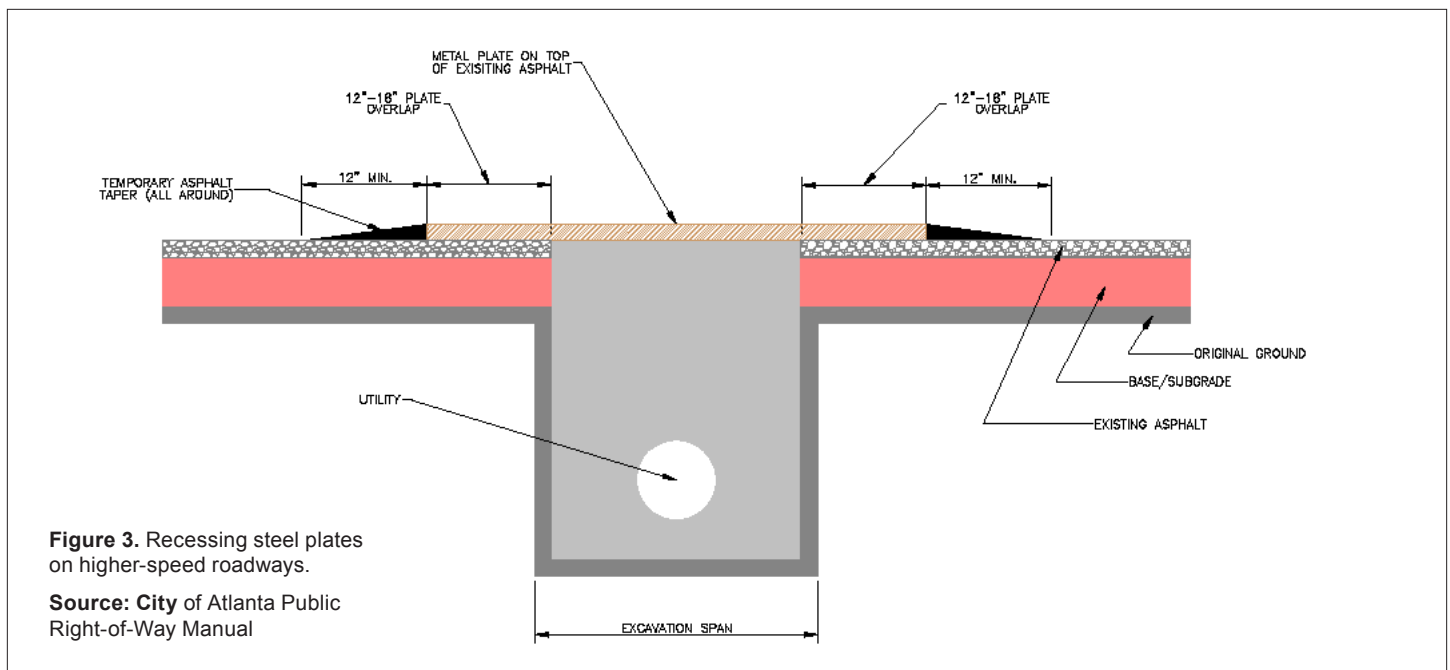

## NOTEWORTHY PRACTICE—

# FRICITION AND PAVEMENT MARKINGS, SOUTHERN STATES\*



Source: Shutterstock

### FLORIDA DOT

**Subject Area\*\*:** Low-Friction Pavement Markings

#### Strategies

- Specify frictional properties for pavement markings that cover large areas
- Consider installing demo projects through maintenance

### BACKGROUND

Friction on the roadway is especially important for motorcycles due to the lower number of contact points (two tires versus four) and importance of each of these contact points in overall stability. While pavement friction itself is often measured, friction of the pavement markings that go on top of the pavement is not always measured. States are increasing the use of pavement markings placed in the center of a lane to assist motorists, like interstate shields used for guidance (Figure 4). The Manual on Uniform Traffic Control Devices (MUTCD) Section 3B.20

describes pavement word, symbol, and arrow markings in use, including these interstate shields. The MUTCD does note that “consideration should be given to selecting pavement marking materials that will minimize tripping or loss of traction for road users, including pedestrians, bicyclists, and motorcyclists.”<sup>(1)</sup> However, research has shown that it can be difficult to provide for both retroreflectivity and friction of pavement markings at the same time.<sup>(2)</sup> Therefore, some of these large markings, due to their large surface area and need for retroreflectivity, can potentially provide a loss of friction in wet or damp conditions, particularly for motorcyclists.

### CHALLENGES

Daytona Beach, Florida, is a well-known destination for many tourists. During the annual Bike Week event, the area particularly attracts motorcyclists. I-95 is the main interstate route north and south of Daytona Beach. Florida DOT is adding shields to some high-profile roadways to improve guidance and potentially reduce wrong-way crashes. The DOT recently added shield markings on I-95 near Daytona Beach. As shown in Figure 5, the shields cover a large portion of the lane, limiting the ability to traverse the lane without crossing over the pavement marking. Frictional properties of pavement markings are a noted concern of motorcyclists.<sup>(2)</sup>

\* Pavement markings tend to be different in northern and southern States due to climate.

\*\* The Motorcyclist Advisory Council (MAC) identified 11 areas related to infrastructure that affect motorcyclists' safety. The full MAC report and other resources can be found at <https://safety.fhwa.dot.gov/motorcycles/>.

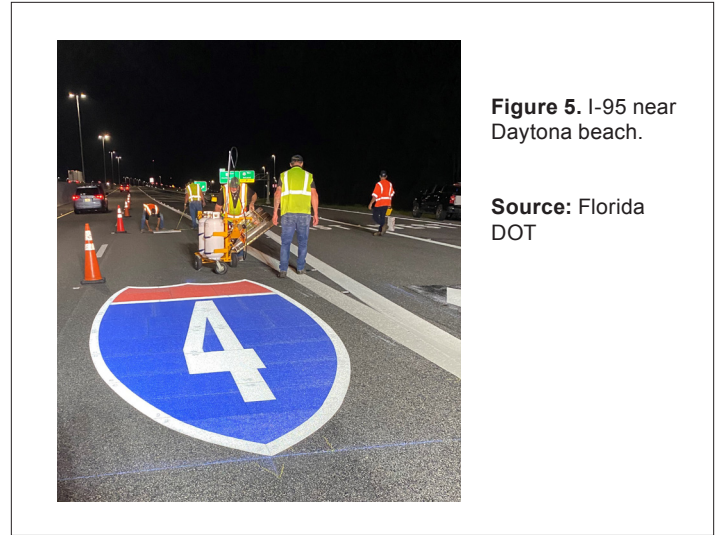
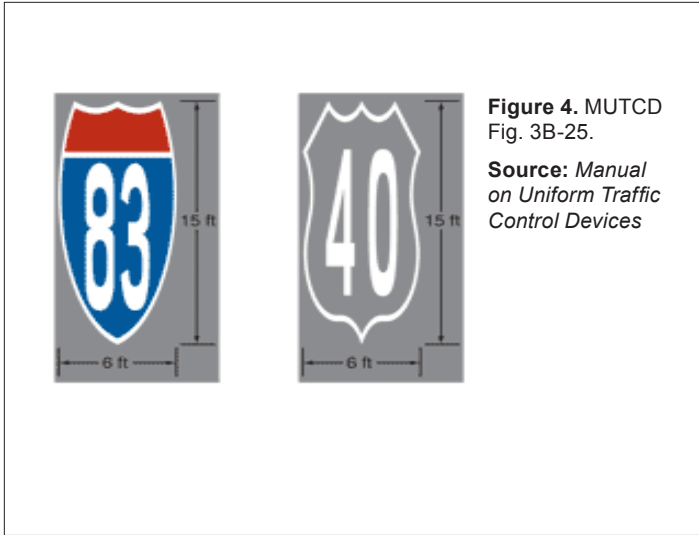

### NOTEWORTHY PRACTICE DESCRIPTION

Due to the potential volume of motorcycles on the road, Florida DOT specified pavement marking materials for an I-95 pavement marking maintenance project that would provide additional frictional characteristics for the shields and words placed on the pavement. Florida DOT District 5 engineers worked with local suppliers to make sure they could meet the higher frictional requirements. The project was a success, and the use of these high-type pavement materials will be considered in the future.

### TAKEAWAYS/LESSONS LEARNED

Florida DOT has been a champion of motorcyclists' safety for many years; it was recognized with a National Roadway Safety Award in 2011 by FHWA for making roadways safer for motorcycles.<sup>(3)</sup>

Florida DOT already has requirements in its specifications for pavement markings with frictional properties.<sup>(4)</sup> These markings are used in crosswalks and bicycle facilities. Florida DOT specifications allow a slightly lower initial retroreflectivity (275 instead of 300 mcd/lx\*m<sup>2</sup>) for these high-friction markings since the DOT recognizes the trade-off between friction and retroreflectivity is currently necessary. The project was a success, and the use of these high-type pavement materials are now being considered as a standard for the future.

### REFERENCES

1. Federal Highway Administration. (2012). *Manual on uniform traffic control devices for streets and highways*. FHWA.
2. Geary, G., Dixon, K., Aspelin, K., & Manser, M. (2021). *Addressing the Motorcyclist Advisory Council recommendations: Synthesis on roadway geometry, pavement design, and pavement construction and maintenance practices* (Report No. FHWA-SA-21-090). Federal Highway Administration. [https://safety.fhwa.dot.gov/motorcycles/docs/FHWA-SA-21-090\\_Addressing\\_MAC\\_Recommendations\\_Rpt.pdf](https://safety.fhwa.dot.gov/motorcycles/docs/FHWA-SA-21-090_Addressing_MAC_Recommendations_Rpt.pdf)
3. Federal Highway Administration. (2011). *National Roadway Safety Awards: Noteworthy practices guide*. [https://rspcb.safety.fhwa.dot.gov/noteworthy/html/vulnerableroadusers\\_fl.aspx?id=104](https://rspcb.safety.fhwa.dot.gov/noteworthy/html/vulnerableroadusers_fl.aspx?id=104)
4. Florida DOT. (2022). *Standard specifications for road and bridge construction*. [https://fdotwww.blob.core.windows.net/sitefinity/docs/default-source/programmanagement/implemented/specbooks/january-2022/january2022-ebook.pdf?sfvrsn=752d1333\\_4](https://fdotwww.blob.core.windows.net/sitefinity/docs/default-source/programmanagement/implemented/specbooks/january-2022/january2022-ebook.pdf?sfvrsn=752d1333_4)

## NOTEWORTHY PRACTICE—

# FRICITION AND PAVEMENT MARKINGS, NORTHERN STATES\*



Source: Shutterstock

### MINNESOTA DOT

**Subject Area\*\*:** Low-Friction Pavement Markings

#### Strategies

- Consider friction management for pavement markings
- Identify locations in need of enhanced friction

### BACKGROUND

Friction on the roadway is especially important for motorcycles due to the lower number of contact points (two tires versus four) and importance of each of these contact points in overall motorcycle stability. While pavement friction itself is often measured, friction of the pavement markings that typically go on top of the pavement is not always measured.

The Manual on Uniform Traffic Control Devices notes that “consideration should be given to selecting pavement marking

materials that will minimize tripping or loss of traction for road users, including pedestrians, bicyclists, and motorcyclists.”<sup>(1)</sup> However, research has noted that it can be difficult to provide for both retroreflectivity and friction of pavement markings at the same time.<sup>(2)</sup> In addition, in northern States, snowplows can cause early failure of pavement markings. To address this situation, Minnesota DOT commonly recesses its longitudinal pavement markings and pavement messages to reduce damage by snowplows; however, placing recessed markings within the lane in a curve, like those needed for roundabouts, can be problematic.

### CHALLENGES

Minnesota DOT is increasingly utilizing roundabouts as a proven safety countermeasure since roundabouts have been shown to provide about an 80 percent reduction in severe crashes compared to typical intersections.<sup>(2)</sup> In fact, Minnesota is one of the top 10 States in roundabout use. Pavement markings are often used to assist in guidance through roundabouts, but recessed pavement markings are not the whole solution since the markings are large and placed within the driving portion of the lane (see Figure 6).

\* Pavement markings tend to be different in northern and southern States due to climate.

\*\* The Motorcyclist Advisory Council (MAC) identified 11 areas related to infrastructure that affect motorcyclists' safety. The full MAC report and other resources can be found at <https://safety.fhwa.dot.gov/motorcycles/>.

## NOTEWORTHY PRACTICE DESCRIPTION

Due to motorcycle community concerns with the pavement markings used in roundabouts, Minnesota DOT is testing a new method using methyl-methacrylate-enhanced skid-resistance markings that include an application of skid-resistant aggregate. Figure 6 shows the roundabout with the new markings located on SR 22 in Mankato, southwest of Minneapolis. A recent research report published by FHWA<sup>(3)</sup> identified the need for friction of pavement markings but found limited research in the United States. The FHWA work did identify some research in progress in Minnesota.

Minnesota DOT has a first-of-its-kind (in over 40 years) research project underway at the University of Minnesota that is investigating differential friction effects caused by pavement markings; the project is titled Pavement Marking/Colored Pavement Friction Differential and Product Durability.<sup>(4)</sup> The Minnesota DOT research project will test existing and newly developed pavement marking materials in a variety of ways and conditions. The research will also test the surrounding pavement to identify potential problems arising from friction differentials.



**Figure 6.** Roundabout markings.

**Source:** Minnesota DOT

Minnesota DOT also commonly uses motorcycle-friendly pedestrian crosswalks (shown in Figure 7) that leave openings in the wheelpaths for motorcycles.

In addition, Minnesota DOT has a technical memorandum on pavement marking operations<sup>(5)</sup> that includes a section specifically related to skid resistance. As part of this document, the DOT also identifies locations where enhanced friction materials should be used, such as crosswalks, railroad crossings, stop lines, and “stop ahead” pavement markings. The Minnesota DOT specifications include enhanced skid-resistant marking requirements that require a British pendulum number of > 60 for pavement markings.



**Figure 7.** Motorcycle-friendly crosswalk markings.

**Source:** Minnesota DOT

## TAKEAWAYS/LESSONS LEARNED

As shown in its crosswalk detail and technical memorandum, and in its pursuit of friction research, Minnesota DOT recognizes the importance of pavement marking friction. The roundabout special project is just another way Minnesota DOT is trying to improve the safety of the travel experience for motorcyclists and all roadway users.

## REFERENCES

1. Federal Highway Administration. (2012). *Manual on uniform traffic control devices for streets and highways*. FHWA.
2. Geary, G., Dixon, K., Aspelin, K., & Manser, M. (2021). *Addressing the Motorcyclist Advisory Council recommendations: Synthesis on roadway geometry, pavement design, and pavement construction and maintenance practices* (Report No. FHWA-SA-21-090). Federal Highway Administration. [https://safety.fhwa.dot.gov/motorcycles/docs/FHWA-SA-21-090\\_Addressing\\_MAC\\_Recommendations\\_Rpt.pdf](https://safety.fhwa.dot.gov/motorcycles/docs/FHWA-SA-21-090_Addressing_MAC_Recommendations_Rpt.pdf)
3. Federal Highway Administration. (2021). Roundabouts. <https://safety.fhwa.dot.gov/provencountermeasures/roundabouts.cfm>
4. Minnesota Department of Transportation. (2021). New project: Pavement marking/colored pavement friction differential and product durability. <https://mntransportationresearch.org/2021/09/10/new-project-pavement-marking-colored-pavement-friction-differential-and-product-durability/>
5. Minnesota Department of Transportation. (2019). *MnDOT provisions for pavement marking operations* (Technical Memorandum No. 19-05-T-02). [https://edocs-public.dot.state.mn.us/edocs\\_public/DMResultSet/download?docId=4899502](https://edocs-public.dot.state.mn.us/edocs_public/DMResultSet/download?docId=4899502)

## NOTEWORTHY PRACTICE—

# MOTORCYCLE ADVISORY SIGN GUIDANCE



Source: *Manual on Uniform Traffic Control Devices*



Source: GGfGA

### MONTANA DOT

**Subject Area\*:** Pothole Maintenance, Open Milled Road Surfaces, Uneven Pavement Conditions, Gravel or Debris on Roadway

#### Strategies

- Recognize construction projects that can increase the risks to motorcyclists
- Be proactive in making motorcyclists aware of construction in time to avoid or reroute
- Implement processes to specify, as needed, use of signs specifically for motorcycles.

### BACKGROUND

Pavement rehabilitation projects in Montana often require milling the pavement surface or removing the asphalt surface and reworking the aggregate base. Traveling through work zones over milled or aggregate surfaces can be especially challenging for motorcyclists because of induced vehicle instability. In response to this concern, several years ago, Montana DOT developed specific motorcycle advisory sign guidance.

### CHALLENGES

Due to the scenic nature of Montana and the confluence of construction and motorcycle riders in the summer, it can be expected that motorcycles are on every single road, especially during summer construction season. Montana has a 511 website ([511mt.net](https://511mt.net)) that includes information on construction activities (like those shown in Figure 8) on MT200 west of Jordan, but not every motorist checks the site before going out on the road. While

\* The Motorcyclist Advisory Council (MAC) identified 11 areas related to infrastructure that affect motorcyclists' safety. The full MAC report and other resources can be found at <https://safety.fhwa.dot.gov/motorcycles/>.



[511mt.net](http://511mt.net) is for all motorists, Montana DOT also has a policy specifically related to construction activities and motorcyclists.

## NOTEWORTHY PRACTICE DESCRIPTION

Since 2013, Montana has had guidance<sup>(1)</sup> on advising motorcyclists of roadway construction so they can make decisions for their traveling comfort and safety. This starts in the preconstruction phase of every project (as part of the traffic management plan), where the length for the project and any associated risks are reviewed for their effect on motorcycles. Projects that involve traffic running on temporary gravel roads or milled surfaces present potentially adverse conditions for motorcycles. These projects are expected to include an advisory sign like the one shown in Figure 9. The signs are specific to a particular project/route and are strategically placed to allow the motorcyclist to stop and check a map or the 511mt.net website to identify alternate routes. At the intersection just past the sign shown here on Hwy 200, there is a rest area that can be used by the motorcyclist.

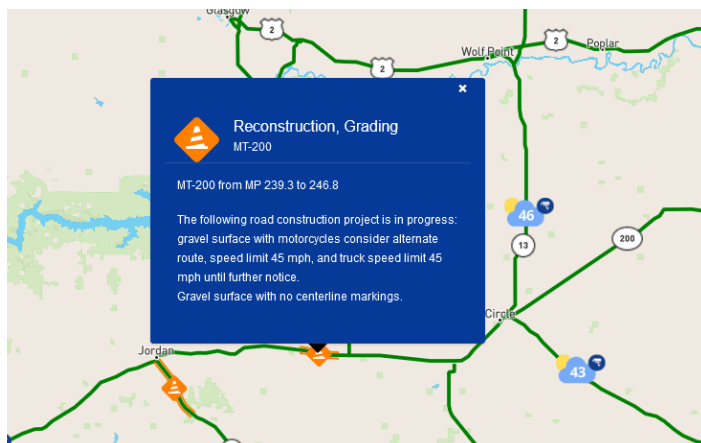

Figure 8. Montana 511 website showing information on a construction project.

Source: Montana DOT 511 website, <http://511mt.net>



Figure 9. Motorcycle advisory sign on MT Hwy 200.

Source: Jeremy Wilde, Montana DOT

## TAKEAWAYS/LESSONS LEARNED

While implementing this new process, Montana DOT interviewed a number of motorcyclists to gather their thoughts on the new signs versus the “Motorcycle Use Extreme Caution” signs that were used previously. The motorcyclists felt that the new signs gave much clearer information and provided them with actionable options compared to the prior signs. Montana has used this signage on a large number of projects, including recent roadwork on Hwy 12 east of Helena and Hwy 47 near Hardin.

Recent research<sup>(2)</sup> has documented the risks of motorcyclists in work zones, and a research project in Ohio<sup>(3)</sup> has shown that 20 percent of motorcyclists would travel 20 miles out of the way to avoid construction work zones. Since the roads in Montana are scenic, that value could be much higher, both in percent and in length.

Soliciting feedback from users (motorcyclists) as Montana did is also a takeaway. FHWA solicited input from motorcyclists in a recent research project looking at different types of novel signage specifically for motorcycle safety<sup>(4)</sup>.

## REFERENCES

1. Montana Department of Transportation. (2013). *Motorcycle advisory sign guidance*. <https://www.mdt.mt.gov/other/webdata/external/const/wzsm/motorcycle-advisory-sign-guidance.pdf>
2. Geary, G., Dixon, K., Aspelin, K., & Manser, M. (2021). *Addressing the Motorcyclist Advisory Council recommendations: Synthesis on roadway geometry, pavement design, and pavement construction and maintenance practices* (Report No. FHWA-SA-21-090). Federal Highway Administration. [https://safety.fhwa.dot.gov/motorcycles/docs/FHWA-SA-21-090\\_Addresssing\\_MAC\\_Recommendations\\_Rpt.pdf](https://safety.fhwa.dot.gov/motorcycles/docs/FHWA-SA-21-090_Addresssing_MAC_Recommendations_Rpt.pdf)
3. Schneider, W. H., Stakleff, B., & Maistros, A. (2013). *Examination of factors associated in motorcycle crashes in work zones* (Report No. FHWA/OH-2013/1). Ohio Department of Transportation.
4. Weaver, S.M., Jannat, M., Savolainen, P.T., and DeFisher, J. (2021). *Novel Highway Signs Study to Support Infrastructure-Based Motorcycle Crash Countermeasures: Phase II*. Report No. FHWA-HRT-21-010, FHWA.

## NOTEWORTHY PRACTICE—

# DETECTING MOTORCYCLES AT TRAFFIC SIGNALS



Source: Shutterstock

### OHIO DOT

**Subject Area\*:** Traffic-Actuated Signal Detection Systems

#### Strategies

- Research the problem and identify solutions
- Consider motorcycle detection requirement at signalized intersections

### BACKGROUND

Due to their smaller size, motorcycles often are not as conspicuous as other vehicles on the roadway. This applies to the detection of motorcycles at traffic signals as well. Ohio has over 400,000 registered motorcyclists, the third highest number in the United

States, behind only California and Florida. Motorcyclists account for about 15 percent of the fatal crashes in Ohio but only 3 percent of the registered vehicles. A driver colliding with a motorcyclist (or other vulnerable user such as a bicyclist or pedestrian) is one of the most common intersection crashes in Ohio. Thirty-six percent of the motorcycle crashes in Ohio occur at intersections.<sup>(1)</sup>

### CHALLENGES

Dilemma zone detectors (which can be pavement loops or pole-mounted radar detectors) detect vehicles approaching an intersection and can extend the green light to allow a vehicle to safely pass through the intersection on green. If a motorcycle is not detected by the dilemma zone detector, the signal could change to yellow at a point where it may be necessary for the motorcyclist to choose between braking hard or entering the intersection at the end of a yellow signal, which could increase the risk of a crash. Motorcyclists that are not detected at signalized intersections, particularly by dilemma zone detectors, are a safety challenge.

\* The Motorcyclist Advisory Council (MAC) identified 11 areas related to infrastructure that affect motorcyclists' safety. The full MAC report and other resources can be found at <https://safety.fhwa.dot.gov/motorcycles/>.

## NOTEWORTHY PRACTICE DESCRIPTION

According to Ohio DOT (personal communication, September 30, 2021), recognizing the concern of motorcyclists and traffic signal detection, engineers at Ohio DOT performed in-house research to identify the best methods to detect motorcycles and bicycles. Through this research, they found that pavement loop detectors that can supply adequate coverage are asymmetrical and diagonal to the traffic (Figure 10). They found that some pole-mounted radar detectors (particularly ones that are larger than about 10 inch by 13 inch) can also identify motorcycles better than other radar detectors. Pole-mounted detectors have the benefit of being able to be installed on bridges and at intersections without damage to the bridge or pavement.

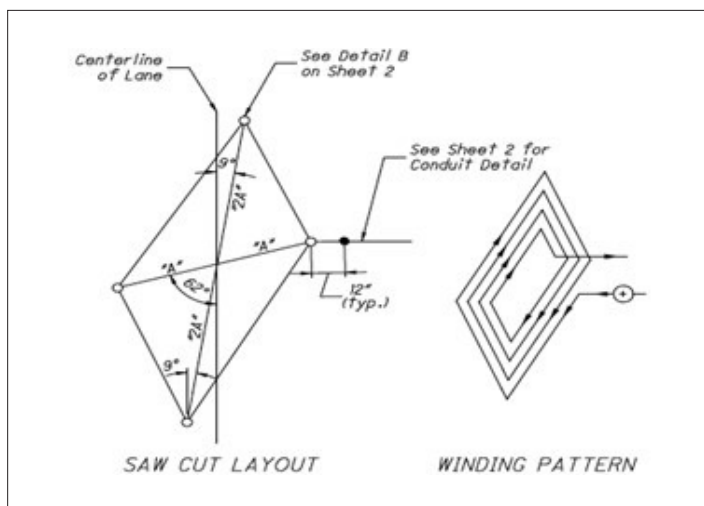

**Figure 10.** Ohio DOT angular design loop detector.

**Source:** Ohio DOT

The Ohio DOT standard construction specifications (Section 632.10 Loop Detector Unit) require that “all stop line detection zones shall reliably detect motorcycles and bicycles, and all dilemma zone detectors shall reliably detect motorcycles.”<sup>(2)</sup>

In Section 632.28, the standard construction specifications include motorcycles in the specific testing requirements for pavement loop detectors: “Check the visual call strength indication of detector units to determine that each vehicle class (truck, car, motorcycle, and bicycle) entering sensor areas is detected on the associated detector unit and that no extraneous calls occur when the sensor area is vacant.”<sup>(2)</sup>

The Ohio DOT Traffic Engineering Manual has a special detail for the equipment to test loops to make sure they will recognize motorcycles.<sup>(3)</sup> When a stop line detector is not visible, Ohio DOT has a special symbol that is placed on the pavement to identify where motorcycles and bicycles can be detected (Figure 11).

Sometimes even correct detectors do not function as expected. Ohio DOT maintains a call number and an email address to report signal detection issues for motorcycles and bicyclists.

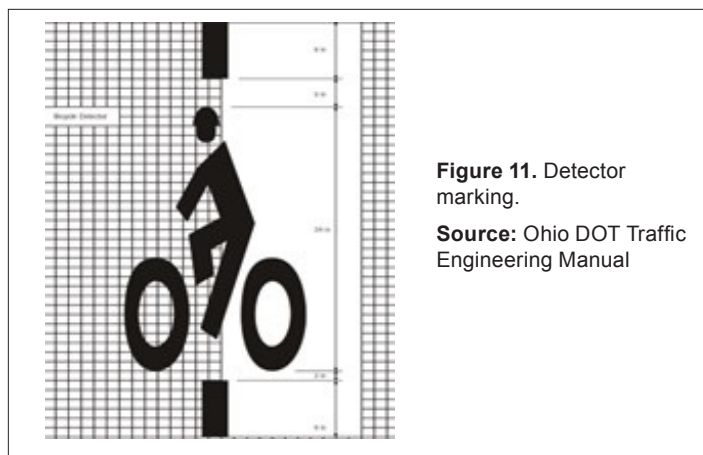

**Figure 11.** Detector marking.

**Source:** Ohio DOT Traffic Engineering Manual

## TAKEAWAYS/LESSONS LEARNED

Motorcycles can be detected by using both the common induction loops installed in the pavement and pole-mounted radar if the detectors are the appropriate configurations, type, and size. Ohio DOT has identified detector types that work for both motorcycles and bicycles. Its standard specifications and construction details clearly show how to install and test the appropriate detection systems. Other States could potentially improve their motorcycle safety at intersections by implementing signal detection equipment that recognizes motorcycles.

## REFERENCES

1. Ohio DOT. (2020). *Strategic Highway Safety Plan*. <https://www.transportation.ohio.gov/working/publications/strategic-highway-safety-plan>
2. Ohio DOT. (2019). *Construction and materials specifications*. <https://www.dot.state.oh.us/Divisions/ConstructionMgt/OnlineDocs/Pages/2019-Online-Spec-Book.aspx>
3. Ohio DOT. (2022). *Traffic engineering manual*. <https://www.dot.state.oh.us/roadway/TEM/Pages/default.aspx>

## NOTEWORTHY PRACTICE—

# HIGH-FRICTION SURFACE TREATMENT FOR MOTORCYCLE SAFETY IN CURVES



Source: Shutterstock

### RHODE ISLAND DOT

**Subject Area\*:** High-Friction Surface Treatment Strategies

#### Strategies

- Consider high-friction surface treatment installation for curve safety
- Develop motorcycle crash trees to help identify risk factors

### BACKGROUND

High-friction surface treatment (HFST) is a widely used safety countermeasure for run-off-the-road crashes, and it has been recognized by the Every Day Counts initiative. FHWA research has found that HFST can reduce injury crashes up to 48% at horizontal curves.<sup>(1)</sup> HFST is a thin pavement surfacing composed

of polish-resistant high-friction aggregate and a polymer binder. It is used in spot locations to enhance the friction capability for vehicles traversing horizontal curves, intersections, and other areas of high-friction demand.

### CHALLENGES

Motorcyclists recognize the challenges of driving in wet weather and will many times postpone travel, if possible, to prevent riding in the rain. However, pavement friction can be reduced in a horizontal curve even without wet weather since the highest stresses occur in curves; this can result in the surface wearing prematurely in a curve, especially curves with small radii. Therefore, regardless of weather, crashes in curves can indicate a friction problem.

Also, identifying locations for HFST treatment based on motorcycle wet-weather crash rates alone may not be viable due to fewer motorcycles on the road than passenger cars and the challenges of acquiring accurate motorcycle vehicle miles traveled.

\* The Motorcyclist Advisory Council (MAC) identified 11 areas related to infrastructure that affect motorcyclists' safety. The full MAC report and other resources can be found at <https://safety.fhwa.dot.gov/motorcycles/>.

## NOTEWORTHY PRACTICE DESCRIPTION

Rhode Island installed HFST on a section of Tunk Hill Road in Scituate (west of Providence, as shown in Figure 12) based on overall crashes in the area. The DOT found that the effort also had an influence on motorcycles. There was an average of one motorcycle crash per year on this section of road in the five years prior to the improvements. After installation of the HFST in 2014, there have been no identified motorcycle crashes.

As part of a horizontal curve systemic safety analysis, Rhode Island identified “motorcycle related crashes as being an overrepresented crash attribute for all fatal and serious injury crashes on curves. Almost half occurred within 1,000’ of curves with a radius between 50’ and 600’. Additionally, almost half of those occurred on curves with an average annual daily traffic (AADT) of less than 7,500 vehicles per day. Most motorcycle crashes occurred on other principal arterials and minor arterials, accounting for 45 (70.3 percent) of KAB motorcycle-involved crashes.”<sup>(2)</sup>



**Figure 12.** High-friction surface treatment installation

**Source:** Rhode Island DOT

Based on its safety analysis of crashes from 2014 to 2018, Rhode Island developed a crash tree for motorcycle crashes, as shown in Figure 13. The DOT also identified a potential relationship between curve radius and KAB motorcycle curve crashes<sup>(3)</sup>:

Predicted KAB curve crashes as a function of radius =  $11.895 * \text{Radius}^{-0.288}$ .

This relationship is being considered, along with functional class and AADT, to perform risk scoring related to motorcycle-involved crash locations. Based on the Tunk Hill Road and other HFST project results, Rhode Island is now considering HFST as a potential countermeasure for motorcycle crashes in curved sections.

## TAKEAWAYS/LESSONS LEARNED

HFST may also benefit motorcyclists, who do not travel as much in inclement weather, and so do not show up as a factor in wet-weather crashes.<sup>(3)</sup> Curves that experience motorcycle crashes should be considered for HFST, not just total wet-weather crashes.

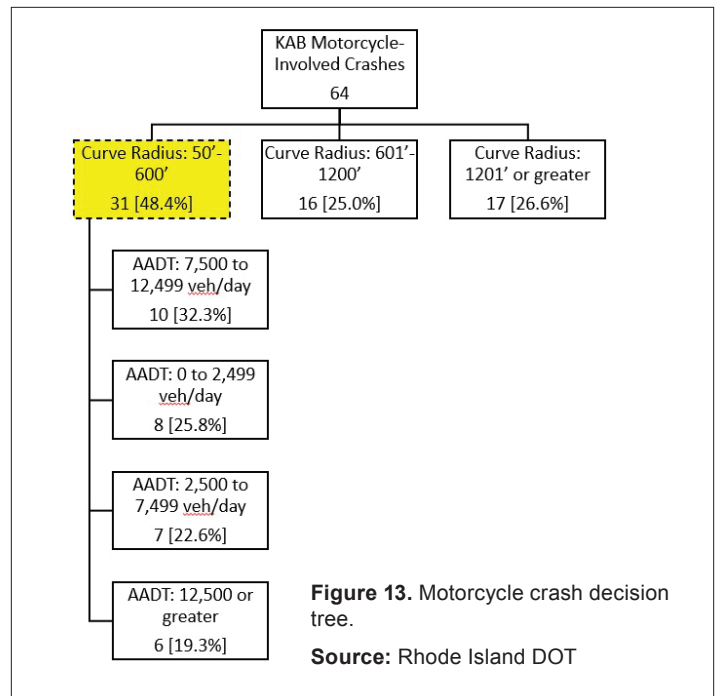

## REFERENCES

1. Federal Highway Administration. (2022). Safety: Proven Safety Countermeasures: Pavement Friction Management. <https://safety.fhwa.dot.gov/provencountermeasures/pavement-friction.cfm>
2. VHB. (2021). Rhode Island DOT horizontal curve systemic safety analysis summary draft document (unpublished).
3. Geary, G., Dixon, K., Aspelin, K., & Manser, M. (2021). *Addressing the Motorcyclist Advisory Council recommendations: Synthesis on roadway geometry, pavement design, and pavement construction and maintenance practices* (Report No. FHWA-SA-21-090). Federal Highway Administration. [https://safety.fhwa.dot.gov/motorcycles/docs/FHWA-SA-21-090\\_Addressing\\_MAC\\_Recommendations\\_Rpt.pdf](https://safety.fhwa.dot.gov/motorcycles/docs/FHWA-SA-21-090_Addressing_MAC_Recommendations_Rpt.pdf)



**Source:** TTI

## NOTEWORTHY PRACTICE—

# MOTORCYCLE ROAD SAFETY AUDIT



Source: Shutterstock

### TENNESSEE DOT

**Subject Area\*:** Barrier Design and Other Special Motorcyclists Needs

#### Strategies

- Conduct road safety audit for motorcycle safety
- Recognize the special needs of motorcyclists

### BACKGROUND

Roads are primarily seen as a method to get from point A to point B, and the most direct connection between two points is a straight line. Mountainous roads typically contain a lot of curves to allow for increasing elevation without being too steep.

Over time, some roads have become not just a part of the destination from A to B, but the destination itself. US 129/SR 115 is one of those roads (see Figure 14). Known in motorcycle circles

as the “Tail of the Dragon,” it is a mountainous road located in the northeast side of Tennessee, south of Knoxville. It is heavily traveled by motorcyclists, and it is so famous that each of the 318 curves on the 11 mile road has its own name.<sup>(1)</sup>

### CHALLENGES

Tight curves, speed, and motorcycles are a precarious combination. A recent synthesis for FHWA on motorcycle safety noted that the lengths and radii of horizontal curves are two features that significantly influence motorcycle crash frequency. The report identified one study that found horizontal curves with radii less than 500 ft were 40 times more likely to have motorcycle-to-barrier crashes than curves with radii of 2,800 ft or greater.<sup>(2)</sup> The study also found horizontal curves with radii of 820 ft or less can be expected to increase crash frequency by a factor of 10. Another study discussed in the same synthesis report found that reverse curves were associated with an increase of about 6 percent in fatal or serious injury crashes.<sup>(2)</sup> US 129/SR 115 has both tight curves and reverse curves.

\* The Motorcyclist Advisory Council (MAC) identified 11 areas related to infrastructure that affect motorcyclists' safety. The full MAC report and other resources can be found at <https://safety.fhwa.dot.gov/motorcycles/>.



Figure 14. Tennessee US 129/ SR 115.

Source: Google Earth

## NOTEWORTHY PRACTICE DESCRIPTION

Recognizing the realities of the Tail of the Dragon, Tennessee DOT has performed road safety audits (RSA) and operational improvement studies on this section of roadway (Tennessee DOT, personal communication, September 30, 2021). Along with the typical engineering and law enforcement members, Tennessee DOT also invited motorcycle club members to be a part of the RSA. Surprising to the other attendees, the motorcycle club members identified guardrails as one of the main concerns. As part of the RSA and an operations safety review, Tennessee DOT looked specifically at the guardrail locations to determine if they could be graded such that it could remove the guardrail. The DOT identified pull-off locations that could be paved to allow a motorcyclist to pull over safely. Also, a major change that resulted from the review was the removal of slower-moving trucks from this section of road. Trucks over 30 ft in length were rerouted from this section of US 129. Long trucks and tight curves can make the road impassible at times, potentially creating a safety concern. More recently, another review resulted in adding half-mile markers to the existing mile markers to assist in emergency response. Tennessee DOT is also now revisiting this section every year to ensure that the roadway itself is not in need of maintenance and that the striping and signs are replaced as necessary and are clearly visible to the roadway users.

## TAKEAWAYS/LESSONS LEARNED

Road safety audits and operational studies are valuable tools to identify potential safety improvements to a section of road. Roads can be more than a means to get from point A to point B—they can also be a destination. When a road has special uses, or if previously underserved groups, like motorcyclists, are involved, it can be beneficial to get stakeholders involved.

## REFERENCES

1. 129 Deals Gap. (n.d.). Tail of the dragon at Deals Gap with 318 curves in 11 miles: America's number one motorcycle and sports car road. <https://tailofthedragon.com>
2. Geary, G., Dixon, K., Aspelin, K., & Manser, M. (2021). *Addressing the Motorcyclist Advisory Council recommendations: Synthesis on roadway geometry, pavement design, and pavement construction and maintenance practices* (Report No. FHWA-SA-21-090). Federal Highway Administration. [https://safety.fhwa.dot.gov/motorcycles/docs/FHWA-SA-21-090\\_Addressing\\_MAC\\_Recommendations\\_Rpt.pdf](https://safety.fhwa.dot.gov/motorcycles/docs/FHWA-SA-21-090_Addressing_MAC_Recommendations_Rpt.pdf)

## NOTEWORTHY PRACTICE— MOTORCYCLE PROTECTION SYSTEM



Source: TTI

### UTAH DOT

**Subject Area\*:** Barrier Design

#### Strategies

- Identify locations where motorcycles may crash into guardrails
- Retrofit guardrails to add motorcycle protection systems

### BACKGROUND

Motorcyclists are at a much higher risk of injury in crashes compared to other motor vehicle occupants. This is especially true for run-off-the-road crashes. Traditionally, roadside barriers are commonly used to reduce crash severity in these types of crashes. However, impacting barriers themselves can be injurious

or deadly. A recent report noted that motorcyclists account for 3 percent of registered vehicles but 40 percent of guardrail-impact-related fatalities.<sup>(1)</sup> The same report noted that motorcyclists often slide into a barrier and end up impacting the support posts instead of the intended upper-rail portion of the guardrail.

### CHALLENGES

Utah DOT classified locations on State routes where motorcycle-guardrail crashes were occurring and identified and installed the commercially available motorcycle protection system (MPS) DR-46 on State Route 35, which appears to have reduced crashes. The commercial product involved sole-source and foreign material issues, which made procurement difficult.

The standard design of a typical guardrail has posts that hold the curved rail. The guardrail system is designed to absorb impact from a car or truck, so the rail itself is mounted above the ground, near the height of a vehicle bumper. While guardrails are designed

\* The Motorcyclist Advisory Council (MAC) identified 11 areas related to infrastructure that affect motorcyclists' safety. The full MAC report and other resources can be found at <https://safety.fhwa.dot.gov/motorcycles/>.





**Figure 15.** Utah DOT standard W-beam with powder coating.

**Source:** Utah DOT

for typical vehicles, this location of the rail itself also enables the posts to be impacted by smaller objects, like motorcyclists that have lost control and are sliding along the pavement. MPS add a rail element below the standard rail to protect the motorcyclist from impacting the posts directly.

### NOTEWORTHY PRACTICE DESCRIPTION

While Utah DOT had favorable results with the commercial MPS, as noted, procurement was difficult. At the next installation, on State Route 191, the DOT performed a retrofit of a standard crash-tested guardrail by adding a standard W-beam rail that was powder coated yellow. The retrofitted guardrail is shown in Figure 15. Prior to installation of the retrofit Utah experienced an average of one motorcycle injury crash per year. After installation, there were no reported motorcycle crashes in the following three years. There has been no indication that the retrofit affected crashworthiness of the guardrail. The powder-coated rub rail has also maintained the yellow color, even after several winters.

The post transition that was used at the end of the rub rail was created by tucking it in behind the rail. The system is only attached at every sixth post (about 25 ft) to not create over-stiffening<sup>(2)</sup> (schematics of the system can be found at [https://docs.google.com/presentation/d/1TZjWVrEAgc8VbtKPQvbFvTP3RYKq0rFkRBPP5-B7hQY/edit#slide=id.g8d21c6e6ab\\_0\\_52](https://docs.google.com/presentation/d/1TZjWVrEAgc8VbtKPQvbFvTP3RYKq0rFkRBPP5-B7hQY/edit#slide=id.g8d21c6e6ab_0_52)).

### TAKEAWAYS/LESSONS LEARNED

An MPS can be installed on existing guardrails. Sharing information on retrofit MPS possibilities may benefit States with motorcycle safety guardrail concerns. Utah DOT is also a member of the Transportation Pooled Fund TPF-5(482), Development and Evaluation of Roadside Safety Systems for Motorcyclists.<sup>(3)</sup> The TPF has an in-service performance evaluation of implemented motorcycle safety treatments as one of its specific activities.<sup>(3)</sup> The TPF is also looking at options for other type barriers, like the netting shown on the first page for catching motorcyclists that may otherwise be ejected over concrete barriers.

### REFERENCES

1. Silvestri-Dobrovoly, C., Geary, G., Dixon, M., Manser, M., & Chauhan, J. (2021). *Addressing the Motorcyclist Advisory Council recommendations: Synthesis on barrier design for motorcyclists safety* (Report No. FHSW-SA-21-069). Federal Highway Administration. [https://safety.fhwa.dot.gov/motorcycles/docs/FHWA-SA-21-069\\_Addressing\\_MAC\\_Recommendations\\_Rpt.pdf](https://safety.fhwa.dot.gov/motorcycles/docs/FHWA-SA-21-069_Addressing_MAC_Recommendations_Rpt.pdf)
2. The National Academies. (2020). *State panel on experience installing motorcycle barrier in the US: Utah* [Video]. Vimeo. <https://vimeo.com/451165246>
3. Transportation Pooled Fund. Development and evaluation of roadside safety systems for motorcyclists. <https://www.pooledfund.org/Details/Study/709>



Source: TTI





U.S. Department of Transportation  
**Federal Highway Administration**



Source: TTI

MOTORCYCLE SAFETY NOTEWORTHY PRACTICES:

# Infrastructure and Engineering

FHWA-SA-22-032